

## WV 2 Black Edition

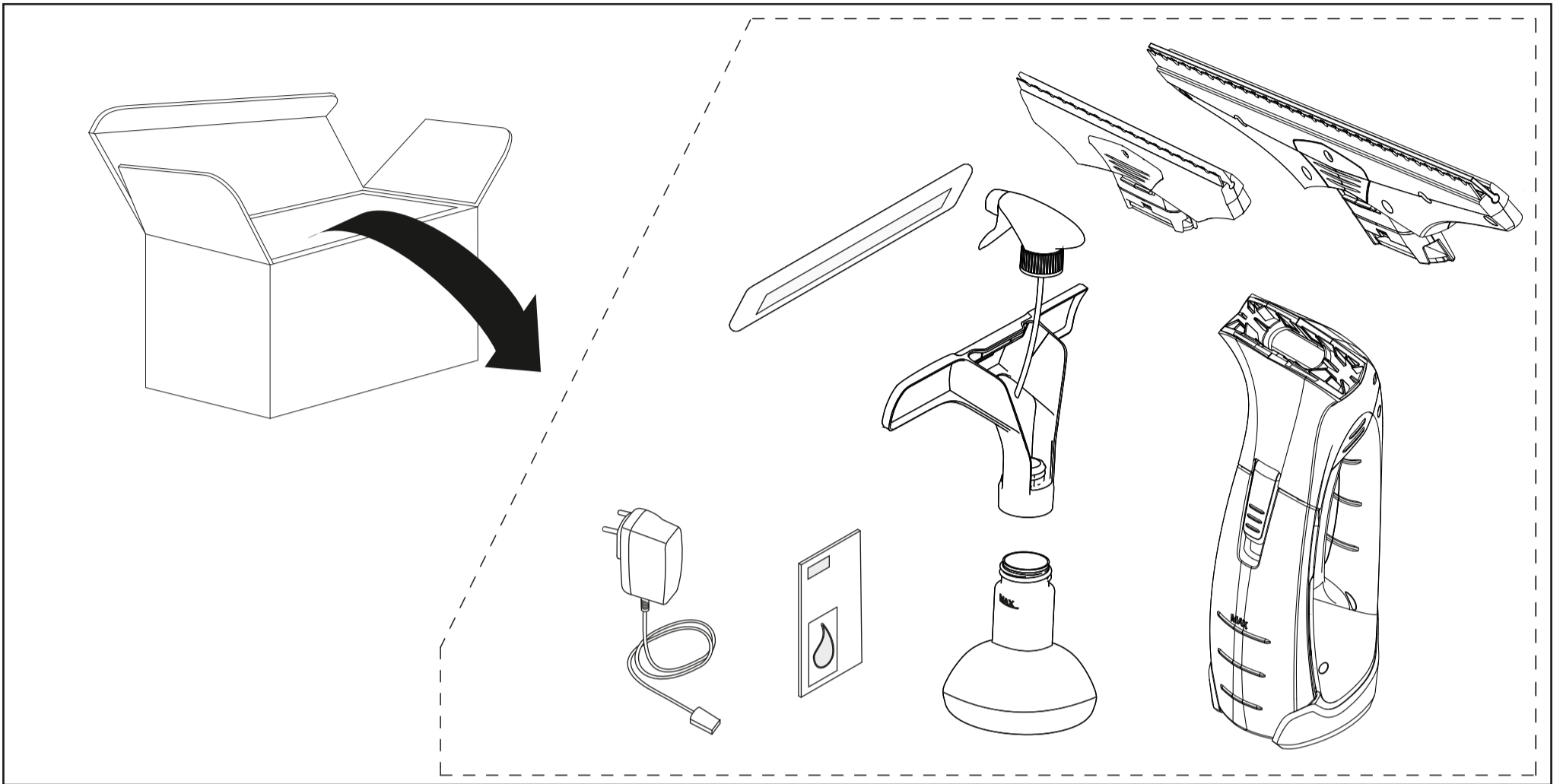

 Li-Ion	3,7 V		IPX4		0,6 kg
 nom	10 W		100 ml		185 min
	5,5 V 600 mA		50 db(A)		35 min

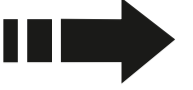
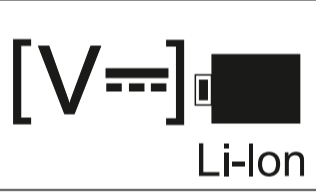
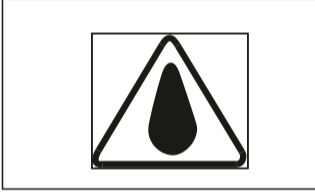
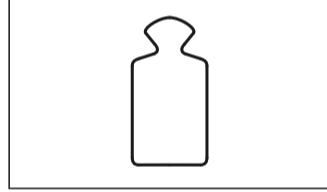
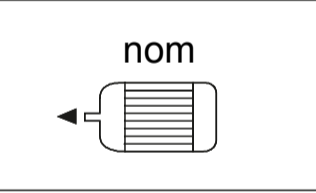
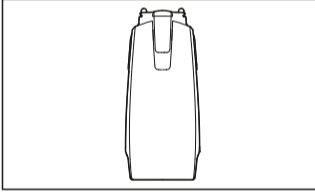
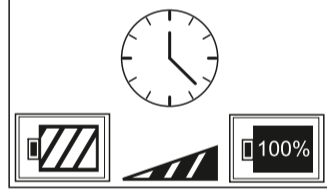
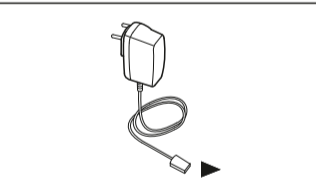
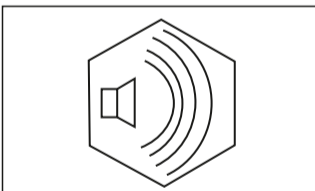
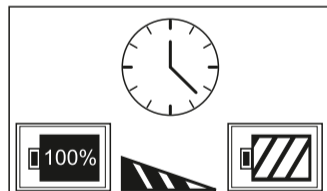
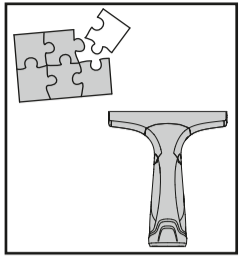

**1**

**2**

**3**

**4**

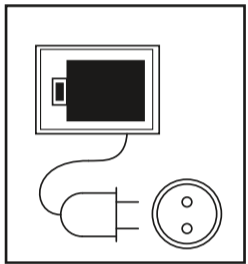

**1**

**2**

**3**

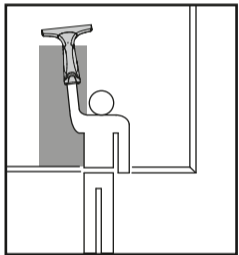

**1**

**2**

**3**

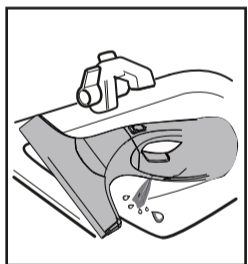

**1**

**2**

**3**

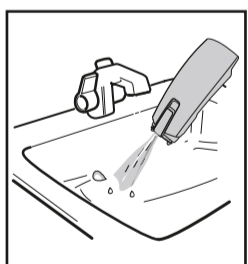

**1**

**2**

**3**

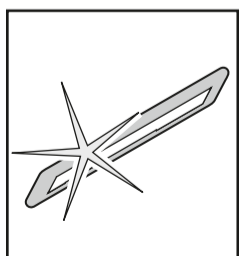

**1**

**2**

